

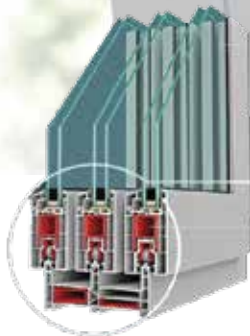

SLIDING 7400

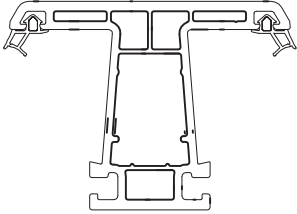



Barra T corredera
7416

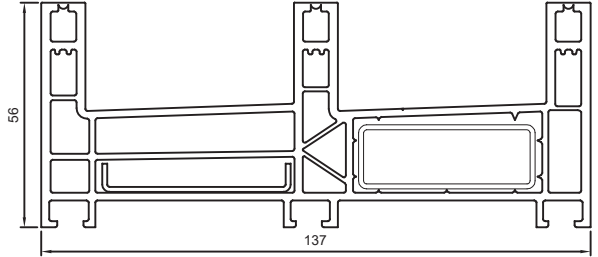

Marco corredera 3 hojas
7413

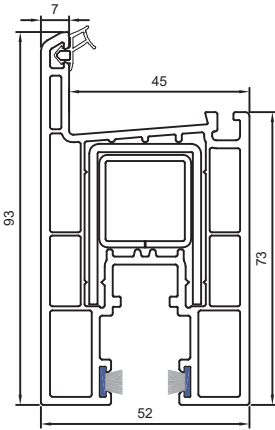

Hoja corredera grande
7414

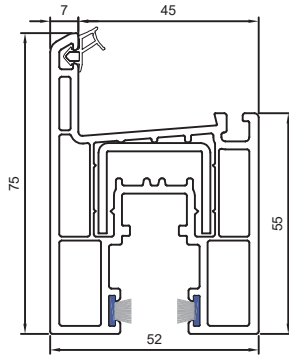

Hoja corredera chica
7415

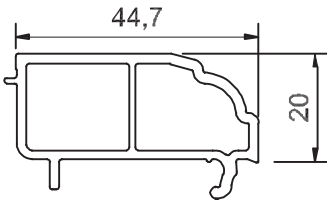

Remate monorriel
7405

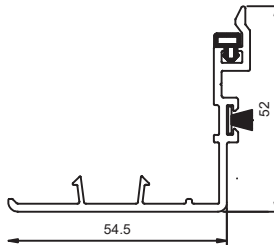

Traslapo hoja corredera grande
7418

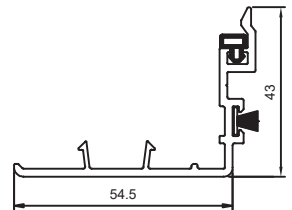

Traslapo hoja corredera chica
7419

Perfiles principales Sliding 7400

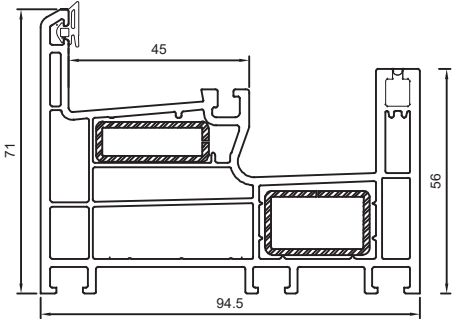

Marco monorriel
7411

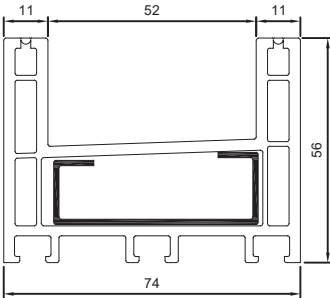
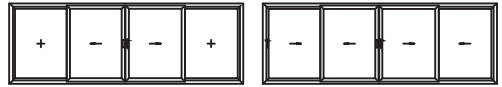
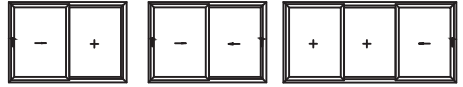

Marco corredera 2 hojas
7401

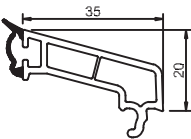
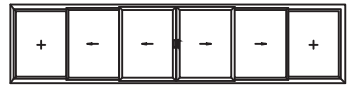

Junquillo para vidrio 4mm
6306

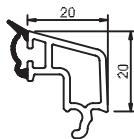

Junquillo para vidrio 20mm
6307

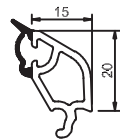

Junquillo para vidrio 24mm
7063

Porque sabemos lo que necesitas,
¡Te invitamos a ser parte del futuro!

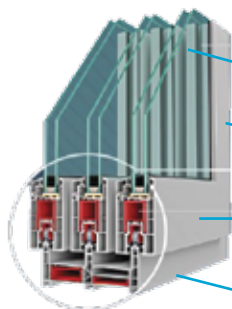

- Acristalamiento de 4-20-24 mm
- Burletes termofusionables incorporados
- Hojas con sistema de doble refuerzo para permitir mayores inercias
- Marco 3 rieles

- Resistente
 - Seguridad
 - Ahorro Energético
 - Bajo mantenimiento
 - Aislante Acústico y térmico
 - Marco 2 rieles
- Garantía RENOLIT

 **VERATEC**®
Sistemas de Ventanas de PVC

Veratec Southamerica SpA.
☒ Carlota Guzmán 1298, Renca, Santiago

Roberto Coloma

Jefe Técnico Comercial

☎ +56 9 7902 8104

✉ roberto.coloma@veratecchile.com

Pablo Salinas

Jefe de Ventas

☎ +56 9 7938 3107

✉ pablo.salinas@veratecchile.com

Bernardo Fernández

Asesor Técnico

☎ +56 9 4028 9758

✉ bernardo.fernandez@veratecchile.com